

BLÜCHER

WATERLINE BADERUMSRENDE

AFLØBSSYSTEMER I RUSTFRIT STÅL

- Stilrent design
- Bryder ikke flisebelægningen
- Justerbar
- Nem vedligeholdelse



**NU MED
DEMONTÉRBAR
VANDLÅS**

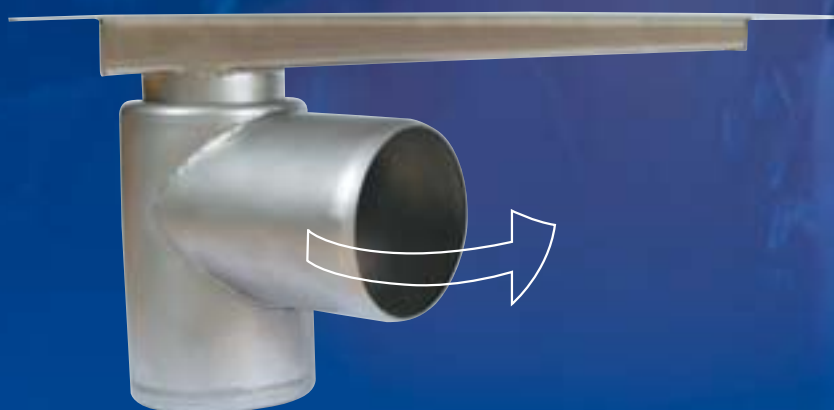

BLÜCHER

Pugdølvej 1 · 7480 Vildbjerg

Tlf. 99 92 08 10

Fax 99 92 08 11

salgdk@blucher.dk

www.blucher.dk

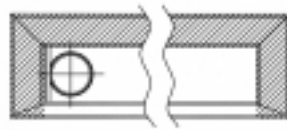
PLACERING:
For/bagvæg +
V-væg + H-væg

VVS nr.	Typenr.	L	X1	X2	X3	X4
15 5056.107	371.070.056.2A	700	15	30	30	30
15 5056.207	371.070.056.2B	700	15	30	30	30
15 5056.108	371.080.056.2A	800	15	30	30	30
15 5056.208	371.080.056.2B	800	15	30	30	30
15 5056.109	371.090.056.2A	900	15	30	30	30
15 5056.209	371.090.056.2B	900	15	30	30	30
15 5056.110	371.100.056.2A	1000	15	30	30	30
15 5056.210	371.100.056.2B	1000	15	30	30	30

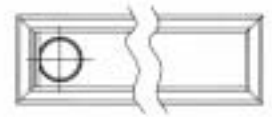
PLACERING:
Uden vægttilslutning

VVS nr.	Typenr.	L	X1	X2	X3	X4
15 5050.107	375.070.056.2A	700	15	15	15	15
15 5050.207	375.070.056.2B	700	15	15	15	15
15 5050.108	375.080.056.2A	800	15	15	15	15
15 5050.208	375.080.056.2B	800	15	15	15	15
15 5050.109	375.090.056.2A	900	15	15	15	15
15 5050.209	375.090.056.2B	900	15	15	15	15
15 5050.110	375.100.056.2A	1000	15	15	15	15
15 5050.210	375.100.056.2B	1000	15	15	15	15

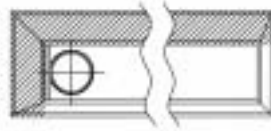
PLACERING:
For/bagvæg + V-væg

VVS nr.	Typenr.	L	X1	X2	X3	X4
15 5055.107	372.070.056.2A	700	15	30	30	15
15 5055.207	372.070.056.2B	700	15	30	30	15
15 5055.108	372.080.056.2A	800	15	30	30	15
15 5055.208	372.080.056.2B	800	15	30	30	15
15 5055.109	372.090.056.2A	900	15	30	30	15
15 5055.209	372.090.056.2B	900	15	30	30	15
15 5055.110	372.100.056.2A	1000	15	30	30	15
15 5055.210	372.100.056.2B	1000	15	30	30	15

PLACERING:
V-væg + H-væg

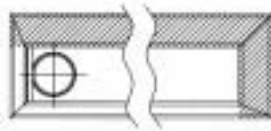

VVS nr.	Typenr.	L	X1	X2	X3	X4
15 5052.107	376.070.056.2A	700	15	15	30	30
15 5052.207	376.070.056.2B	700	15	15	30	30
15 5052.108	376.080.056.2A	800	15	15	30	30
15 5052.208	376.080.056.2B	800	15	15	30	30
15 5052.109	376.090.056.2A	900	15	15	30	30
15 5052.209	376.090.056.2B	900	15	15	30	30
15 5052.110	376.100.056.2A	1000	15	15	30	30
15 5052.210	376.100.056.2B	1000	15	15	30	30

PLACERING:
For/bagvæg + H-væg

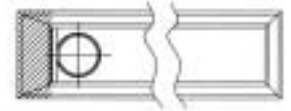
VVS nr.	Typenr.	L	X1	X2	X3	X4
15 5054.107	373.070.056.2A	700	15	30	15	30
15 5054.207	373.070.056.2B	700	15	30	15	30
15 5054.108	373.080.056.2A	800	15	30	15	30
15 5054.208	373.080.056.2B	800	15	30	15	30
15 5054.109	373.090.056.2A	900	15	30	15	30
15 5054.209	373.090.056.2B	900	15	30	15	30
15 5054.110	373.100.056.2A	1000	15	30	15	30
15 5054.210	373.100.056.2B	1000	15	30	15	30

PLACERING:
V-væg eller H-væg

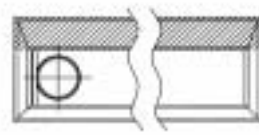
VVS nr.	Typenr.	L	X1	X2	X3	X4
15 5051.107	377.070.056.2A	700	15	15	30	15
15 5051.207	377.070.056.2B	700	15	15	30	15
15 5051.108	377.080.056.2A	800	15	15	30	15
15 5051.208	377.080.056.2B	800	15	15	30	15
15 5051.109	377.090.056.2A	900	15	15	30	15
15 5051.209	377.090.056.2B	900	15	15	30	15
15 5051.110	377.100.056.2A	1000	15	15	30	15
15 5051.210	377.100.056.2B	1000	15	15	30	15

PLACERING:
For/bagvæg

VVS nr.	Typenr.	L	X1	X2	X3	X4
15 5053.103	374.030.056.2A	300	15	30	15	15
15 5053.203	374.030.056.2B	300	15	30	15	15
15 5053.107	374.070.056.2A	700	15	30	15	15
15 5053.207	374.070.056.2B	700	15	30	15	15
15 5053.108	374.080.056.2A	800	15	30	15	15
15 5053.208	374.080.056.2B	800	15	30	15	15
15 5053.109	374.090.056.2A	900	15	30	15	15
15 5053.209	374.090.056.2B	900	15	30	15	15
15 5053.110	374.100.056.2A	1000	15	30	15	15
15 5053.210	374.100.056.2B	1000	15	30	15	15

Ristevarianter:

Render med hulrist: xxx.xxx.xxx.xA

Render med spalterist: xxx.xxx.xxx.xB

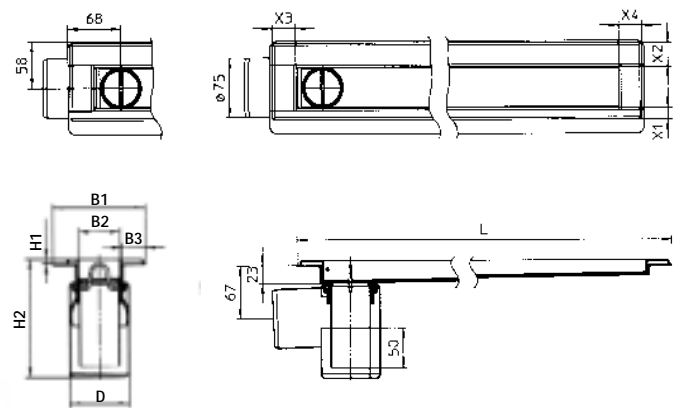

Rammen er konstrueret således, at "fugen ligger i væggen" – derfor den ekstra brede ramme.

Med denne konstruktion forlænges levetiden for fugen, da den ikke er eksponeret for vand i længere perioder. Da "fugen ligger i væggen" er der forskel på bredden af rammen, og det er derfor meget afgørende, hvor i rummet renden skal placeres.

Rammer, som skal ligge op til væg, er 30 mm brede, mens fritliggende rammer er 15 mm brede. Den brede 30 mm ramme skal faktisk nærmest bygges ind i væggen, og med fliser, fliseklæb og fugemasse vil den synlige del af rammen blive ca. 15 mm hele vejen rundt.

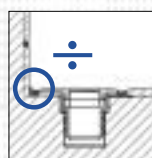
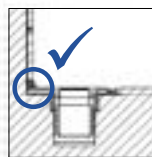
Demonterbar vandlås

VVS nr.	Typenr.	D	H1	H2	B1	B2	B3
15 5059.113	510.000.075	75	6-14	149-157	117	52	30